

Scheda n° 16

Appartamento	Mq. 101,81
Box - auto	Mq. 15,77
Superficie compl.	Mq. 117,58
Importo mq.	€. 1.723,94
TOTALE VENDITA	€. 202.700,86 + IVA

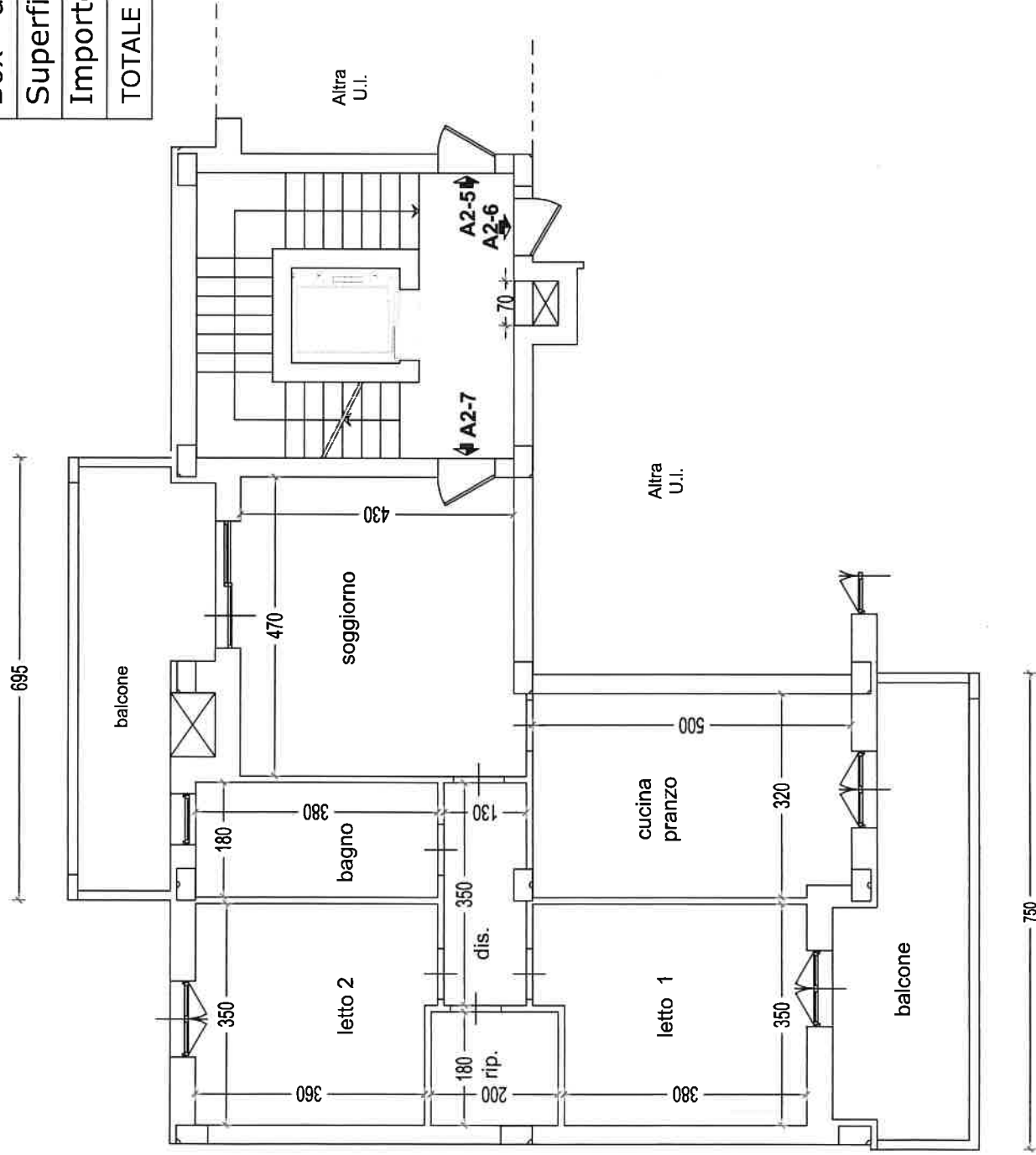

Piano 1° Int. A2-05

Scheda n° 17

Appartamento	Mq. 74,95
Box - auto	Mq. 15,92
Superficie compl.	Mq. 90,87
Importo mq.	€. 1.723,94
TOTALE VENDITA	€. 156.654,43 + IVA

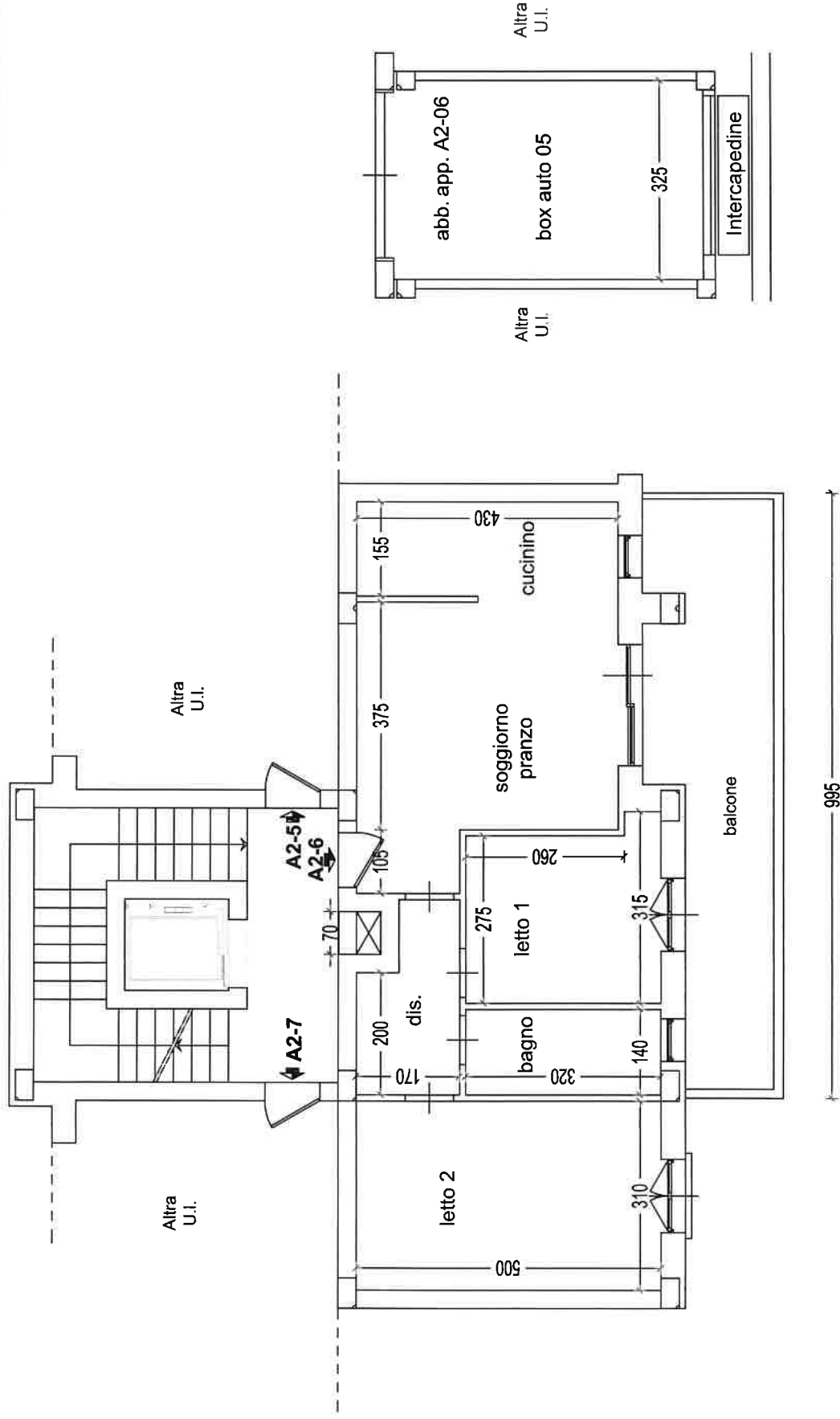

Piano 1° Int. A2-06

Scheda n° 18

Appartamento	Mq. 108,60
Box - auto	Mq. 21,17
Superficie compl.	Mq. 129,77
Importo mq.	€. 1.723,94
TOTALE VENDITA	€. 223.715,69 + IVA

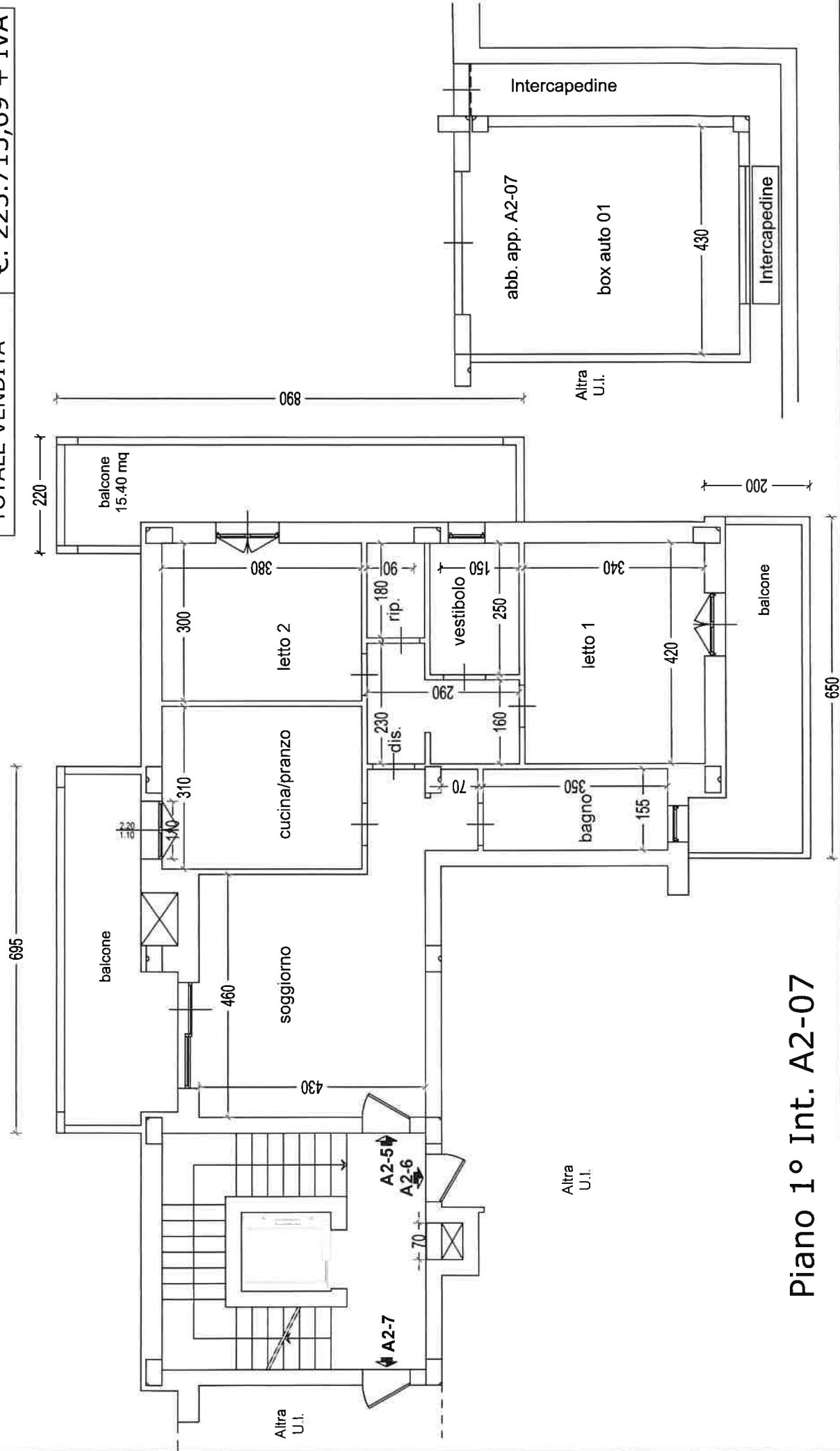

Piano 1° Int. A2-07

Scheda n°19

Appartamento	Mq. 101,81
Box - auto	Mq. 17,82
Superficie compl.	Mq. 119,63
Importo mq.	€. 1.723,94
TOTALE VENDITA	€. 206.234,94 + IVA

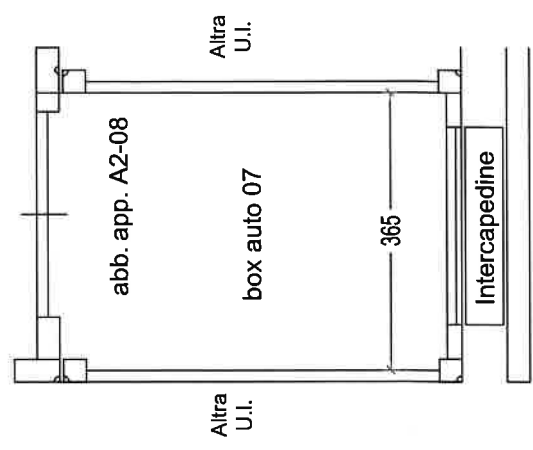
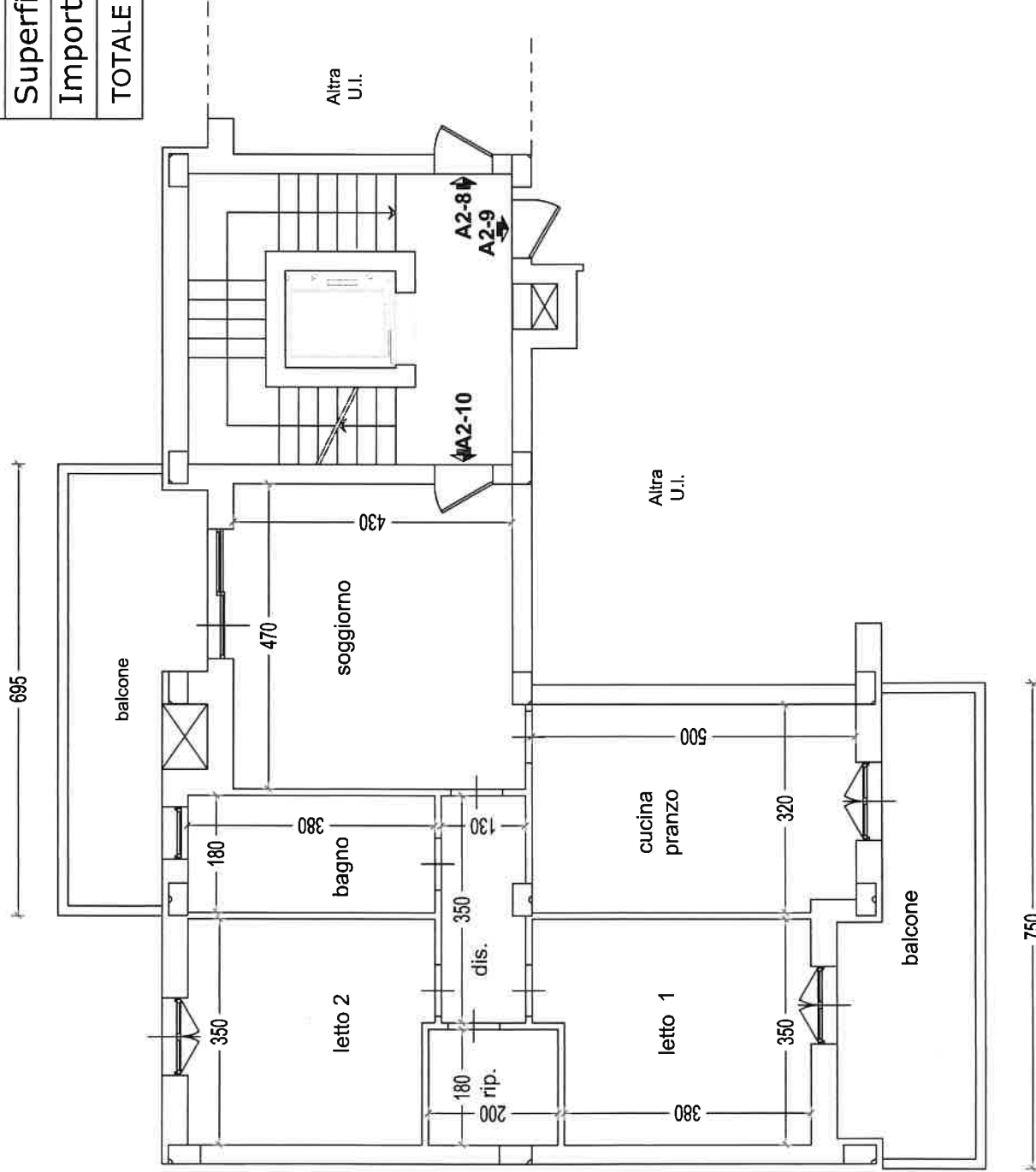

Piano 2° Int. A2-08

Scheda n° 20

Appartamento	Mq. 72,83
Box - auto	Mq. 15,29
Superficie compl.	Mq. 88,12
Importo mq.	€. 1.723,94
TOTALE VENDITA	€. 151.913,59 + IVA

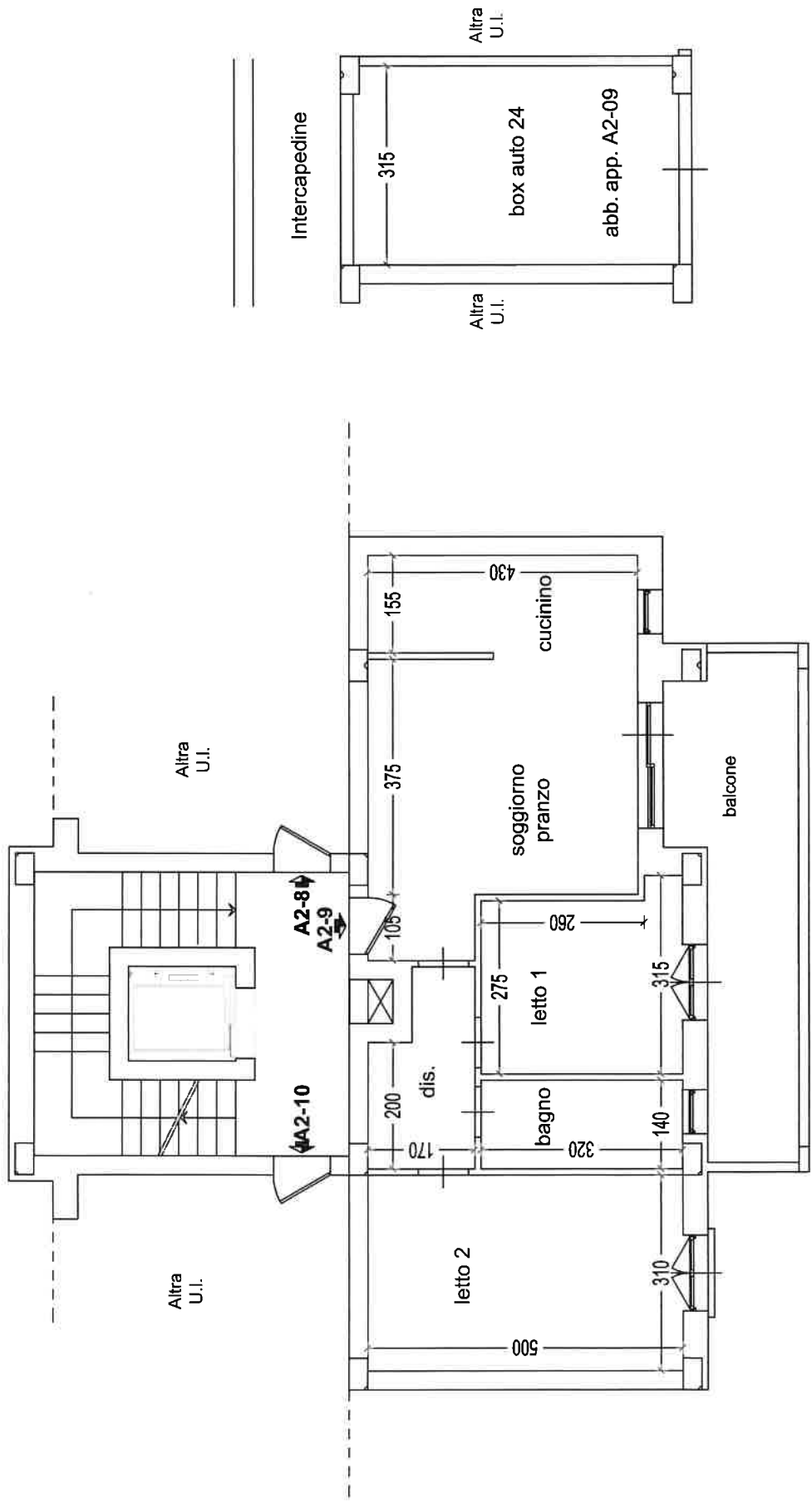

Piano 2° Int. A2-09

Scheda n° 21

Appartamento	Mq. 107,76
Box - auto	Mq. 16,07
Superficie compl.	Mq. 123,83
Importo mq.	€. 1.723,94
TOTALE VENDITA	€. 213.475,49 + IVA

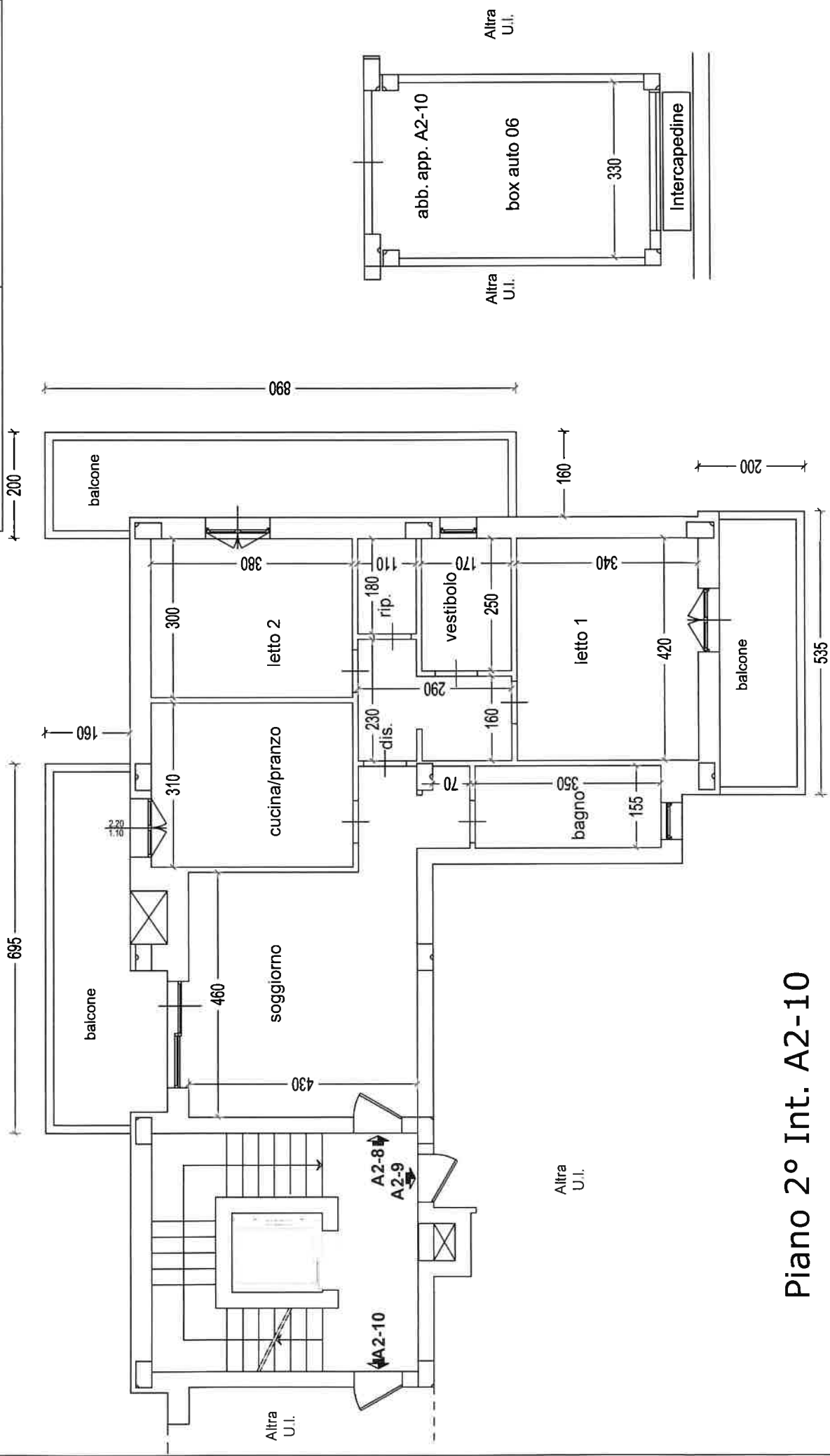

Piano 2° Int. A2-10

Scheda n° 22

Appartamento	Mq. 105,51
Box - auto	Mq. 17,82
Superficie compl.	Mq. 123,33
Importo mq.	€. 1.723,94
TOTALE VENDITA	€. 212.613,52 + IVA

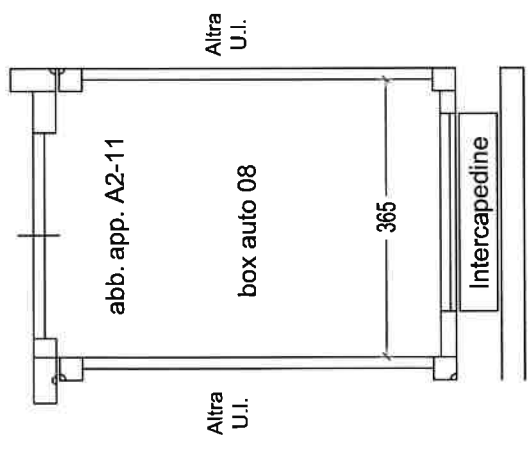
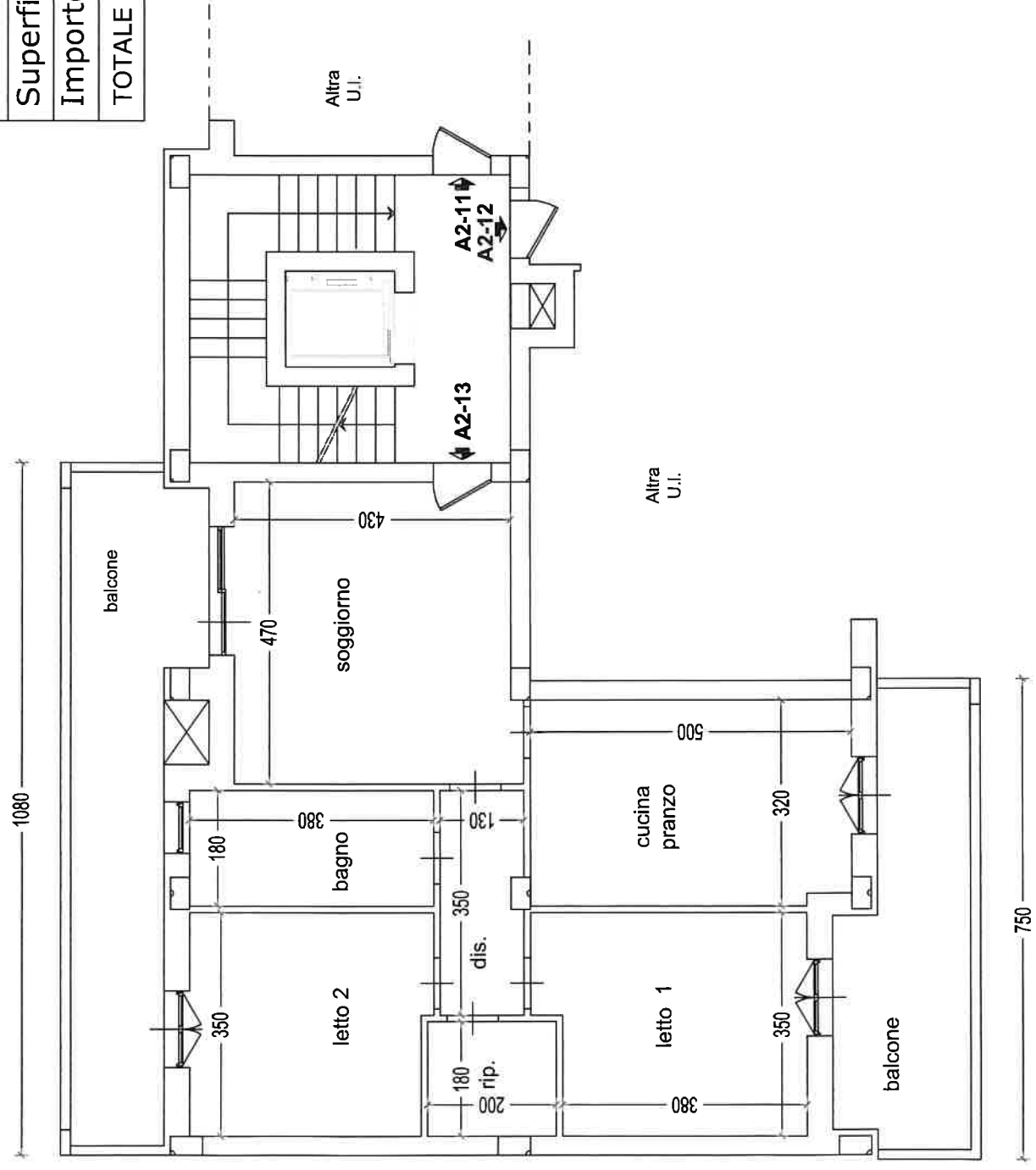

Piano 3° Int. A2-11

Scheda n° 23

Appartamento	Mq. 72,8276
Box - auto	Mq. 15,9924
Superficie compl.	Mq. 88,8200
Importo mq.	€. 1.723,94
TOTALE VENDITA	€. 153.120,98 + IVA

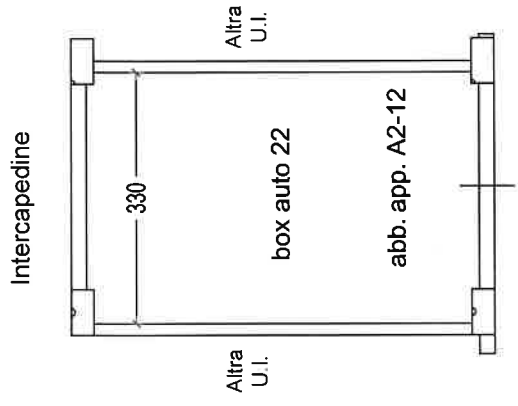
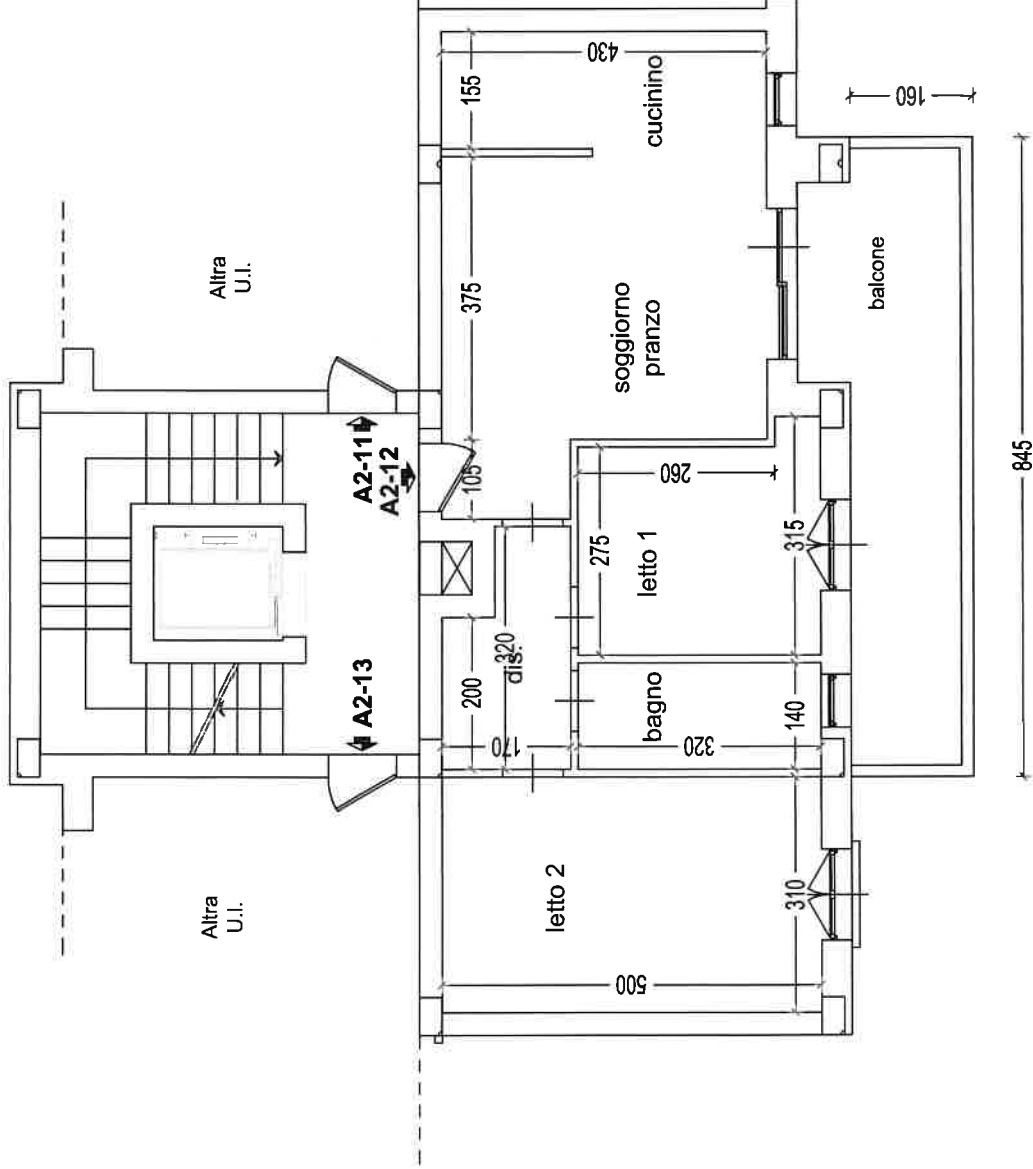

Piano 3° Int. A2-12

Scheda n° 24

Appartamento	Mq. 106,57
Box - auto	Mq. 17,72
Superficie compl.	Mq. 124,29
Importo mq.	€. 1.723,94
TOTALE VENDITA	€. 214.268,50 + IVA

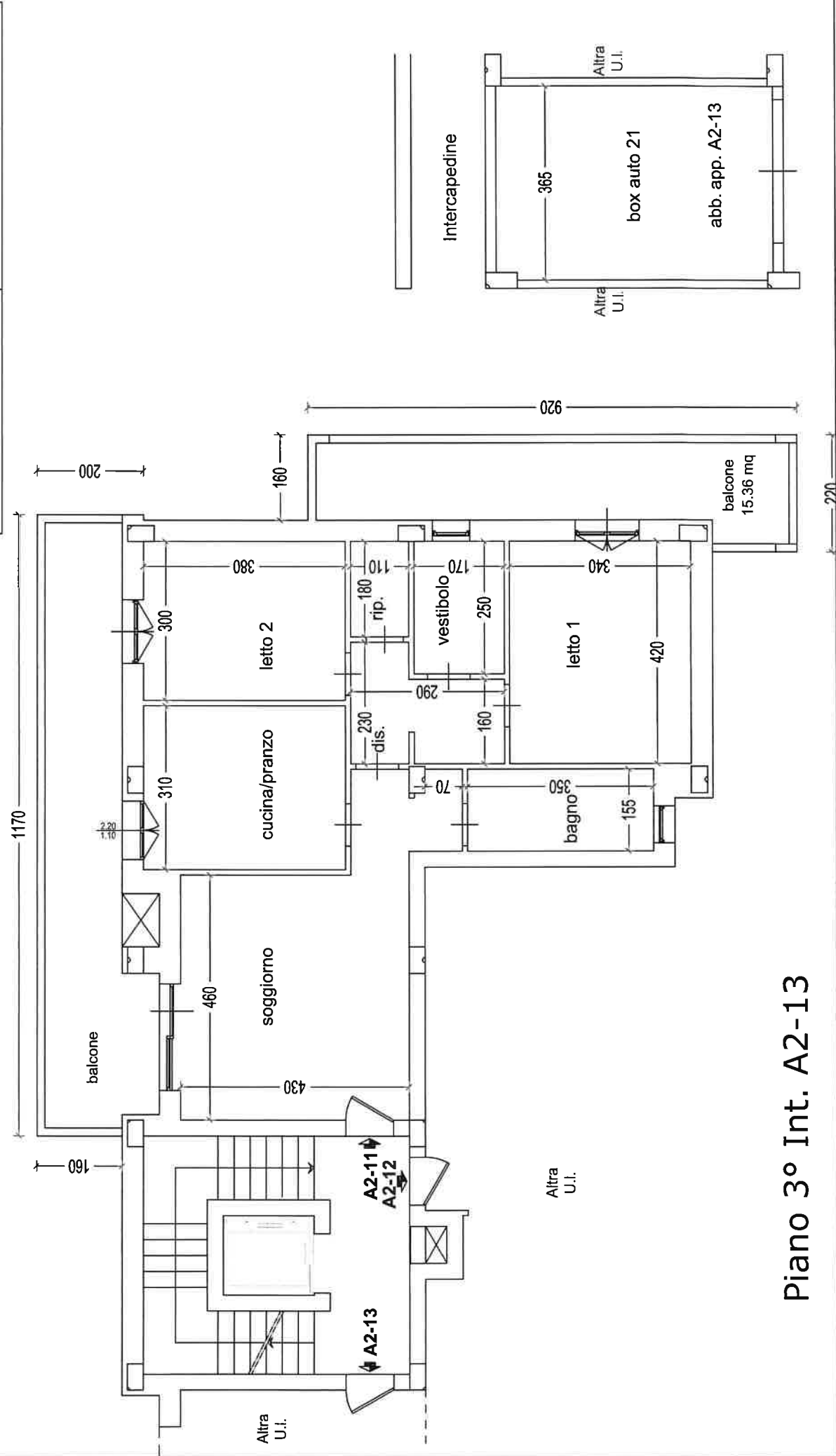

Piano 3° Int. A2-13

Scheda n° 25

Appartamento	Mq. 105,5088
Box - auto	Mq. 21,9628
Superficie compl.	Mq. 127,4716
Importo mq.	€. 1.723,94
TOTALE VENDITA	€. 219.753,34 + IVA

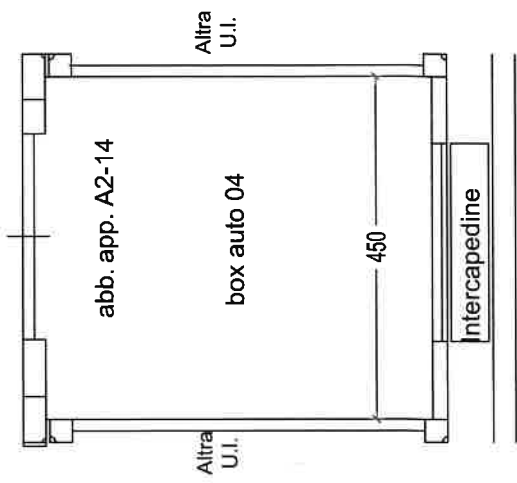
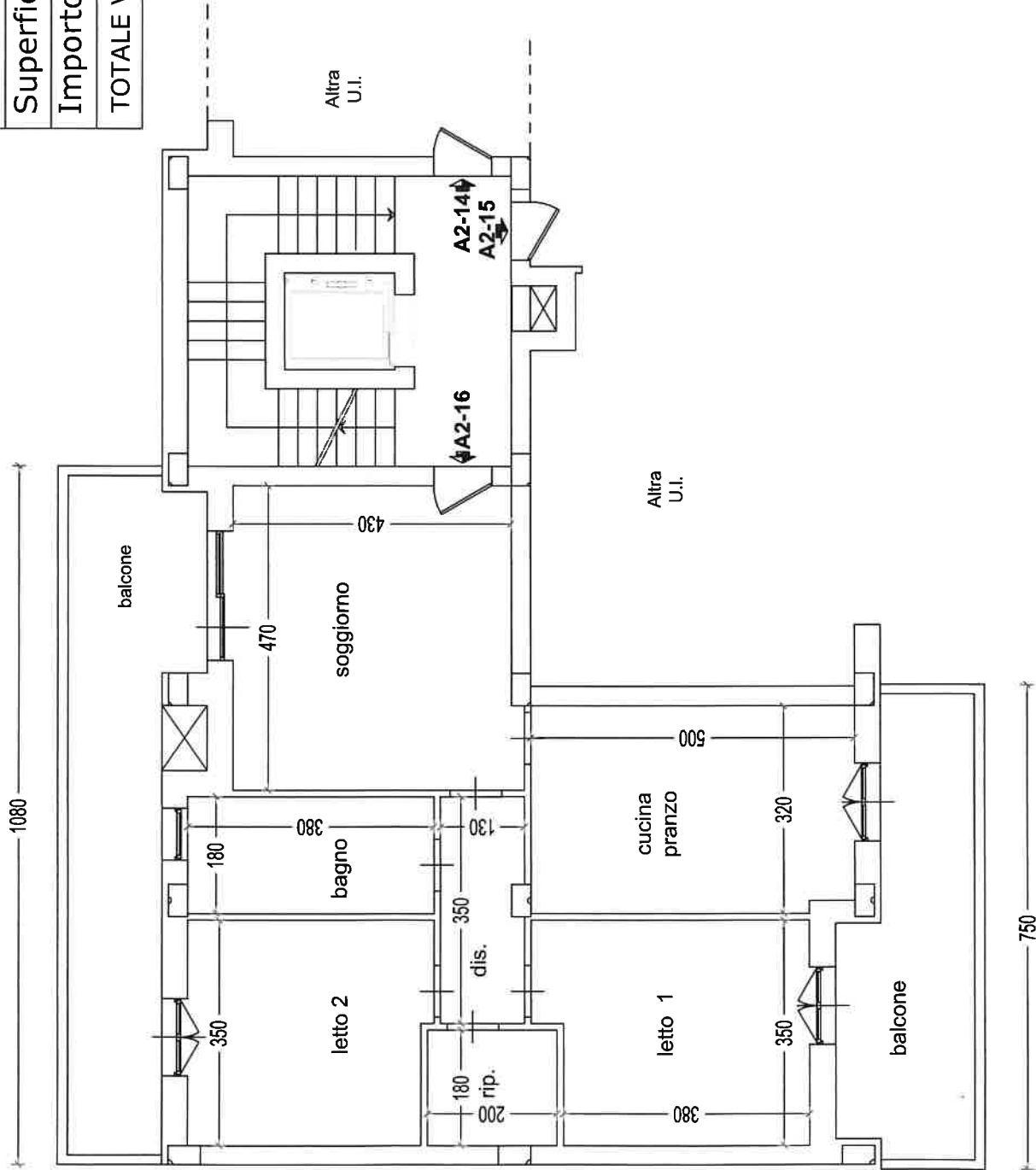

Piano 4° Int. A2-14

Scheda n° 26

Appartamento	Mq. 72,8276
Box - auto	Mq. 16,0576
Superficie compl.	Mq. 88,8852
Importo mq.	€. 1.723,94
TOTALE VENDITA	€. 153.232,87 + IVA

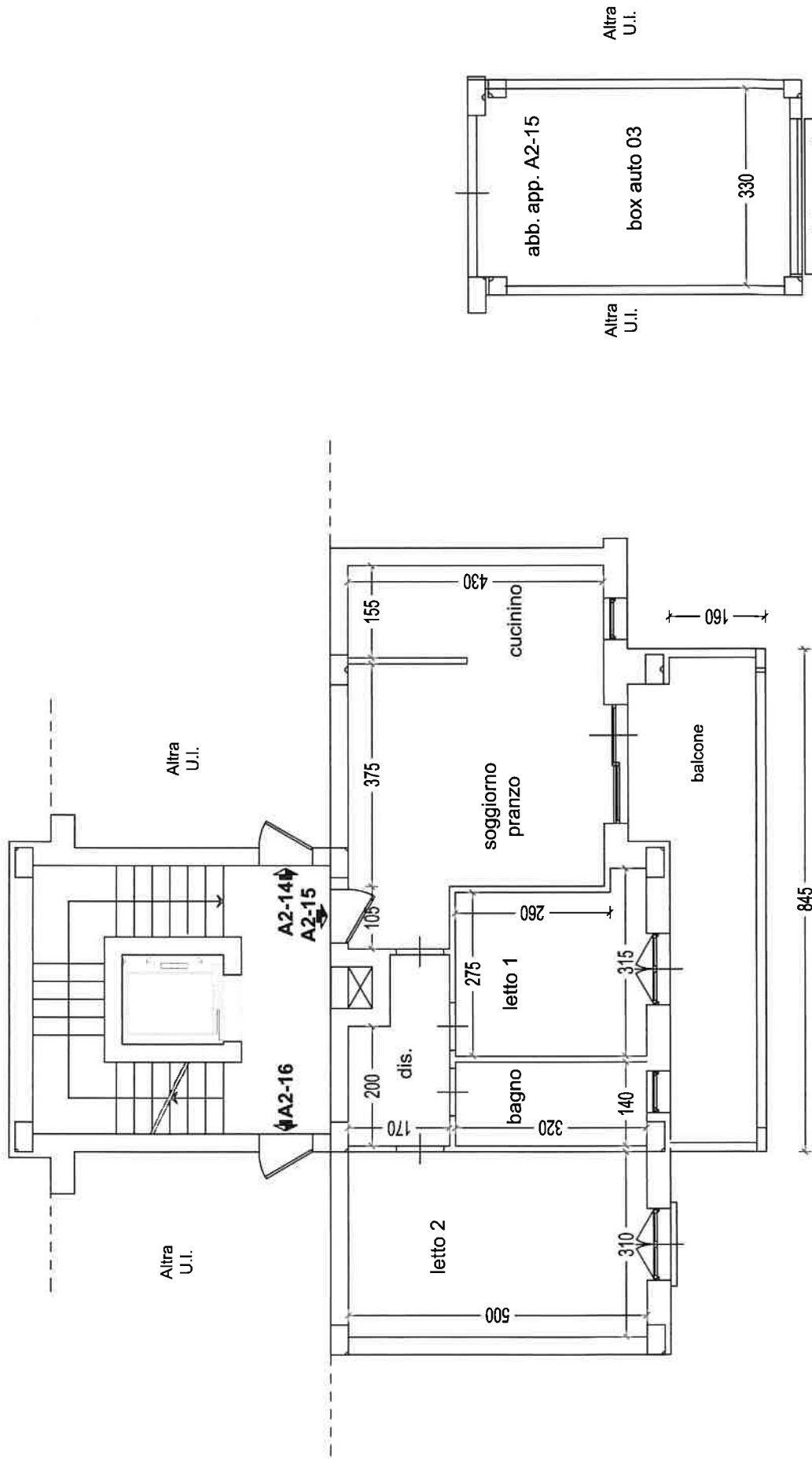

Piano 4° Int. A2-15

Scheda n° 27

Appartamento	Mq. 108,87
Box - auto	Mq. 36,94
Superficie compl.	Mq. 145,81
Importo mq.	€. 1.723,94
TOTALE VENDITA	€. 251.367,69 + IVA

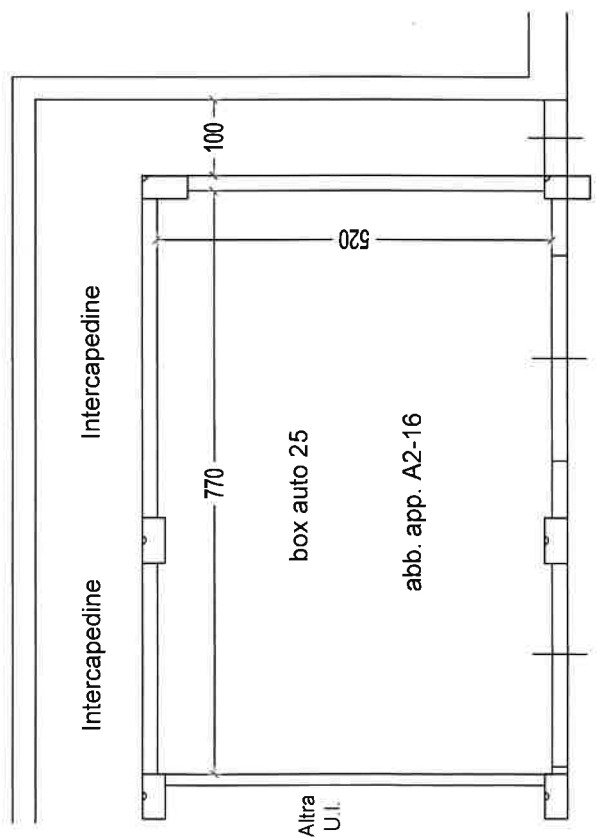
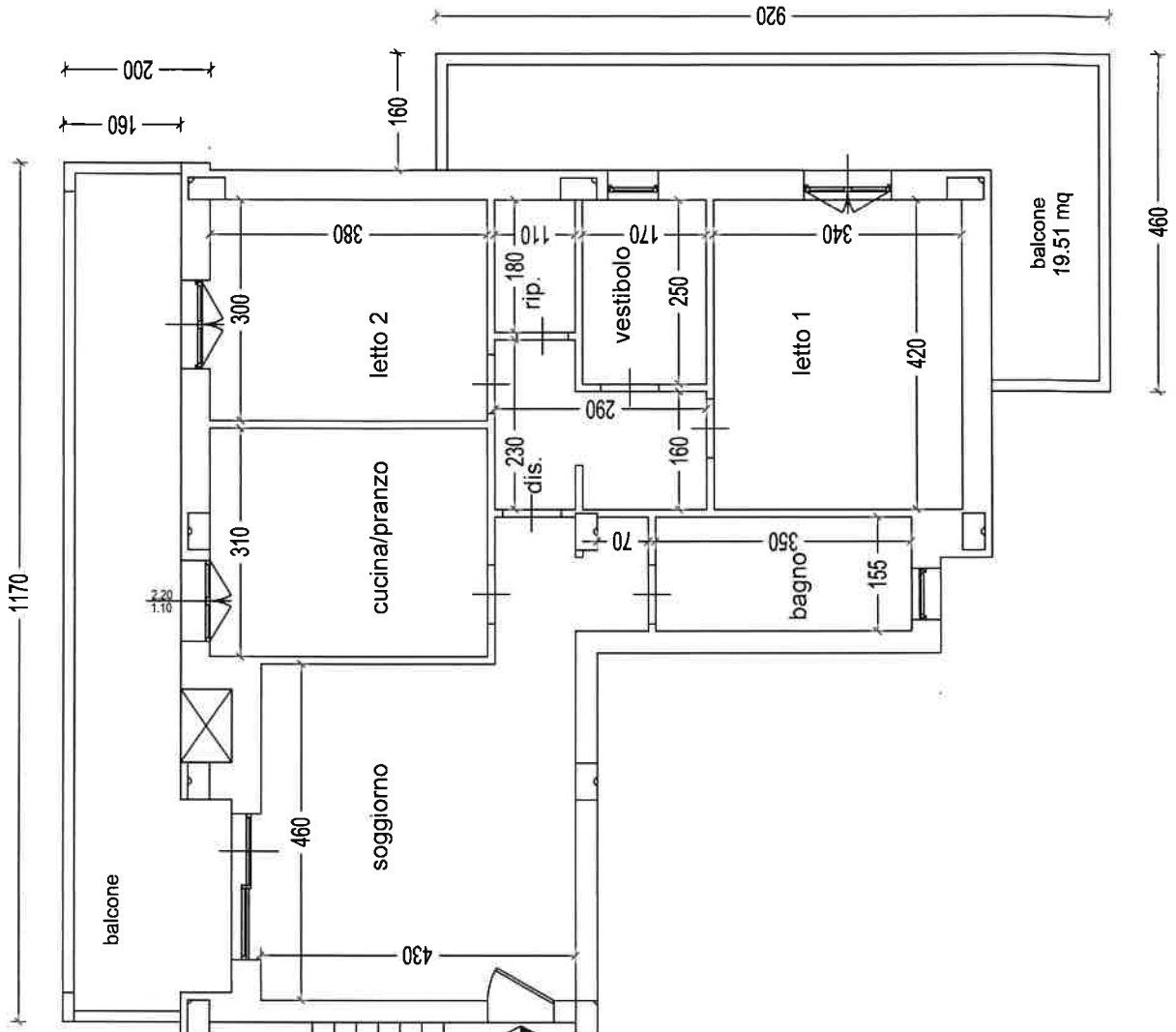

Piano 4° Int. A2-16